

Thyristor Modules

Thyristor/Diode Modules

$I_{TRMS} = 2x 300 A$
 $I_{TAVM} = 2x 130 A$
 $V_{RRM} = 800-1800 V$

| V_{RSM} V_{DSM} V | V_{RRM} V_{DRM} V | Type | |
|-----------------------------|-----------------------------|---------------|---------------|
| | | Version 1 | Version 1 |
| 900 | 800 | MCC 132-08io1 | MCD 132-08io1 |
| 1300 | 1200 | MCC 132-12io1 | MCD 132-12io1 |
| 1500 | 1400 | MCC 132-14io1 | MCD 132-14io1 |
| 1700 | 1600 | MCC 132-16io1 | MCD 132-16io1 |
| 1900 | 1800 | MCC 132-18io1 | MCD 132-18io1 |

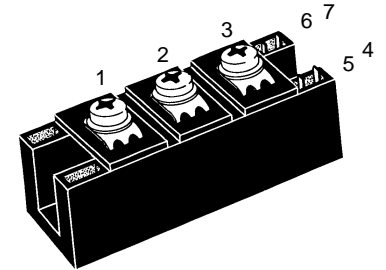

| Symbol | Test Conditions | Maximum Ratings | |
|--|--|--|--|
| I_{TRMS}, I_{FRMS} I_{TAVM}, I_{FAVM} | $T_{VJ} = T_{VJM}$ $T_C = 85^\circ C; 180^\circ$ sine | 300 | A |
| I_{TSM}, I_{FSM} | $T_{VJ} = 45^\circ C;$ $V_R = 0$ | t = 10 ms (50 Hz), sine t = 8.3 ms (60 Hz), sine | A A |
| | $T_{VJ} = T_{VJM}$ $V_R = 0$ | t = 10 ms (50 Hz), sine t = 8.3 ms (60 Hz), sine | A A |
| $\int i^2 dt$ | $T_{VJ} = 45^\circ C$ $V_R = 0$ | t = 10 ms (50 Hz), sine t = 8.3 ms (60 Hz), sine | 113 000 A ² s 108 000 A ² s |
| | $T_{VJ} = T_{VJM}$ $V_R = 0$ | t = 10 ms (50 Hz), sine t = 8.3 ms (60 Hz), sine | 89 500 A ² s 86 200 A ² s |
| $(di/dt)_{cr}$ | $T_{VJ} = T_{VJM}$ f = 50 Hz, t _p = 200 μs $V_D = 2/3 V_{DRM}$ $I_G = 0.5 A$ di _G /dt = 0.5 A/μs | repetitive, I _T = 500 A non repetitive, I _T = 500 A | 150 A/μs 500 A/μs |
| $(dv/dt)_{cr}$ | $T_{VJ} = T_{VJM};$ $R_{GK} = \infty;$ method 1 (linear voltage rise) | $V_{DR} = 2/3 V_{DRM}$ | 1000 V/μs |
| P_{GM} | $T_{VJ} = T_{VJM}$ $I_T = I_{TAVM}$ | t _p = 30 μs t _p = 500 μs | 120 W 60 W |
| P_{GAV} | | | 8 W |
| V_{RGM} | | | 10 V |
| T_{VJ} | | | -40...+125 °C |
| T_{VJM} | | | 125 °C |
| T_{stg} | | | -40...+125 °C |
| V_{ISOL} | 50/60 Hz, RMS $I_{ISOL} \leq 1 mA$ | t = 1 min t = 1 s | 3000 V~ 3600 V~ |
| M_d | Mounting torque (M6) Terminal connection torque (M6) | | 2.25-2.75/20-25 Nm/lb.in. 4.5-5.5/40-48 Nm/lb.in. |
| Weight | Typical including screws | | 125 g |

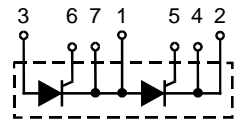
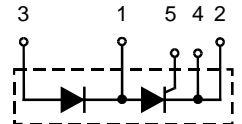
MCC

MCD

Features

- International standard package
- Direct copper bonded Al₂O₃ -ceramic base plate
- Planar passivated chips
- Isolation voltage 3600 V~
- UL registered, E 72873
- Keyed gate/cathode twin pins

Applications

- Motor control
- Power converter
- Heat and temperature control for industrial furnaces and chemical processes
- Lighting control
- Contactless switches

Advantages

- Space and weight savings
- Simple mounting
- Improved temperature and power cycling
- Reduced protection circuits

Data according to IEC 60747 and refer to a single thyristor/diode unless otherwise stated. IXYS reserves the right to change limits, test conditions and dimensions

| Symbol | Test Conditions | Characteristic Values |
|--------------------|--|-----------------------|
| I_{RRM}, I_{DRM} | $T_{VJ} = T_{VJM}; V_R = V_{RRM}; V_D = V_{DRM}$ | 10 mA |
| V_T, V_F | $I_T, I_F = 300 \text{ A}; T_{VJ} = 25^\circ\text{C}$ | 1.36 V |
| V_{T0} | For power-loss calculations only ($T_{VJ} = 125^\circ\text{C}$) | 0.8 V |
| r_T | | 1.5 mΩ |
| V_{GT} | $V_D = 6 \text{ V}; T_{VJ} = 25^\circ\text{C}$ | 2.5 V |
| | $T_{VJ} = -40^\circ\text{C}$ | 2.6 V |
| I_{GT} | $V_D = 6 \text{ V}; T_{VJ} = 25^\circ\text{C}$ | 150 mA |
| | $T_{VJ} = -40^\circ\text{C}$ | 200 mA |
| V_{GD} | $T_{VJ} = T_{VJM}; V_D = 2/3 V_{DRM}$ | 0.2 V |
| I_{GD} | | 10 mA |
| I_L | $T_{VJ} = 25^\circ\text{C}; t_p = 30 \mu\text{s}; V_D = 6 \text{ V}$ $I_G = 0.5 \text{ A}; di_G/dt = 0.5 \text{ A}/\mu\text{s}$ | 300 mA |
| I_H | $T_{VJ} = 25^\circ\text{C}; V_D = 6 \text{ V}; R_{GK} = \infty$ | 200 mA |
| t_{gd} | $T_{VJ} = 25^\circ\text{C}; V_D = 1/2 V_{DRM}$ $I_G = 0.5 \text{ A}; di_G/dt = 0.5 \text{ A}/\mu\text{s}$ | 2 μs |
| t_q | $T_{VJ} = T_{VJM}; I_T = 160 \text{ A}, t_p = 200 \mu\text{s}; -di/dt = 10 \text{ A}/\mu\text{s}$ typ. $V_R = 100 \text{ V}; dv/dt = 20 \text{ V}/\mu\text{s}; V_D = 2/3 V_{DRM}$ | 150 μs |
| Q_S | $T_{VJ} = T_{VJM}; I_T, I_F = 300 \text{ A}, -di/dt = 50 \text{ A}/\mu\text{s}$ | 550 μC |
| I_{RM} | | 235 A |
| R_{thJC} | per thyristor/diode; DC current per module | 0.23 K/W |
| R_{thJK} | per thyristor/diode; DC current per module | 0.115 K/W |
| | other values see Fig. 8/9 | 0.33 K/W |
| | | 0.165 K/W |
| d_s | Creepage distance on surface | 12.7 mm |
| d_A | Strike distance through air | 9.6 mm |
| a | Maximum allowable acceleration | 50 m/s ² |

Optional accessories for modules

Keyed gate/cathode twin plugs with wire length = 350 mm, gate = yellow, cathode = red

Type ZY 180L (L = Left for pin pair 4/5) } UL 758, style 1385,
Type ZY 180R (R = right for pin pair 6/7) } CSA class 5851, guide 460-1-1

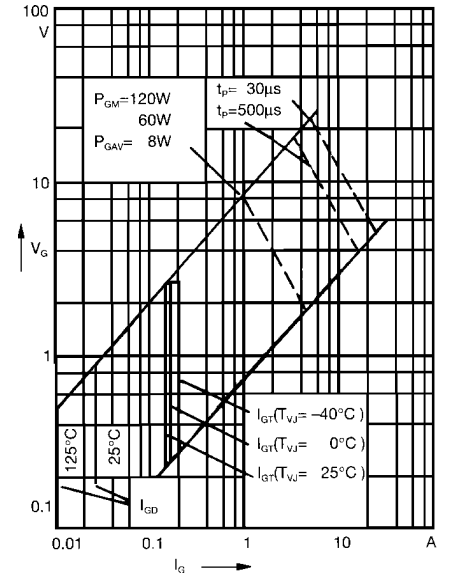

Fig. 1 Gate trigger characteristics



Fig. 2 Gate trigger delay time

Dimensions in mm (1 mm = 0.0394")

MCC

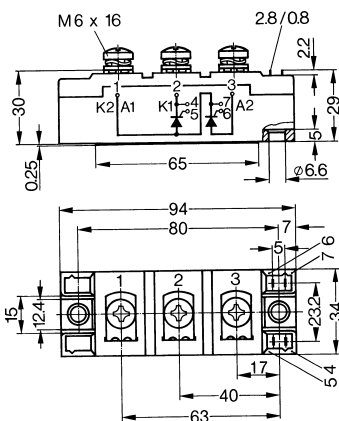

MCD

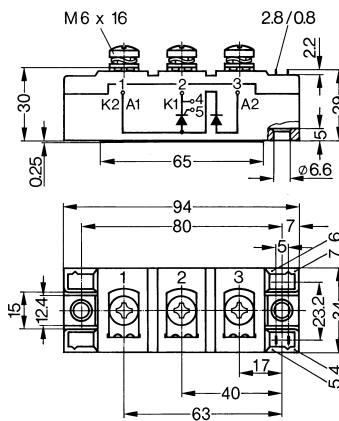

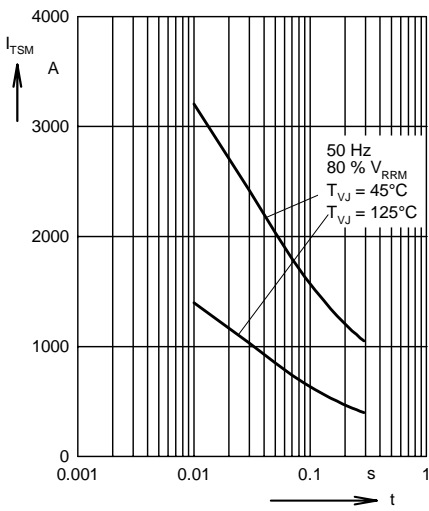

Fig. 3 Surge overload current
 I_{TSM} , I_{FSM} : Crest value, t: duration

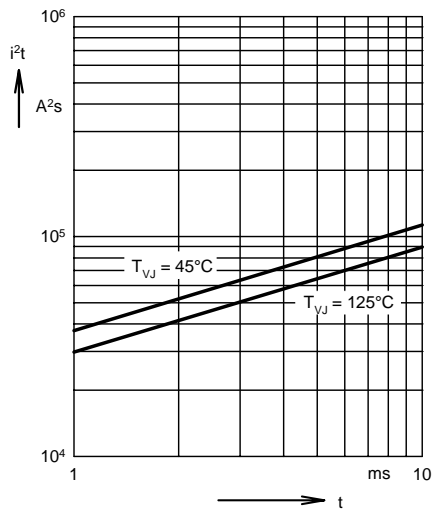

Fig. 4 i^2t versus time (1-10 ms)

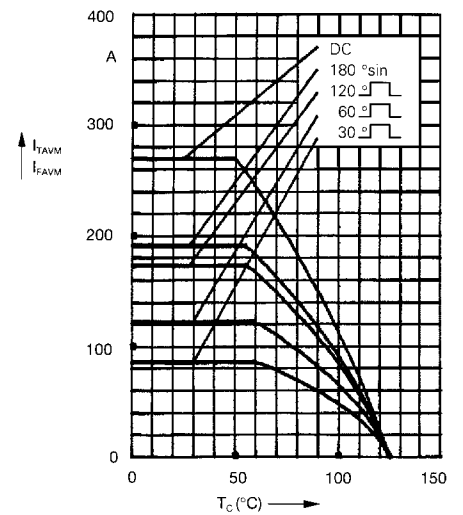

Fig. 4a Maximum forward current at case temperature

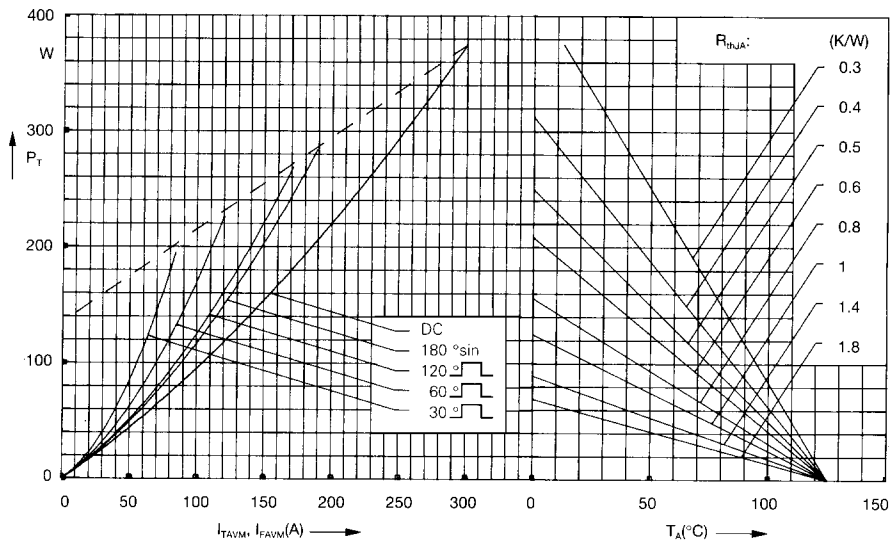

Fig. 5 Power dissipation versus on-state current and ambient temperature (per thyristor or diode)

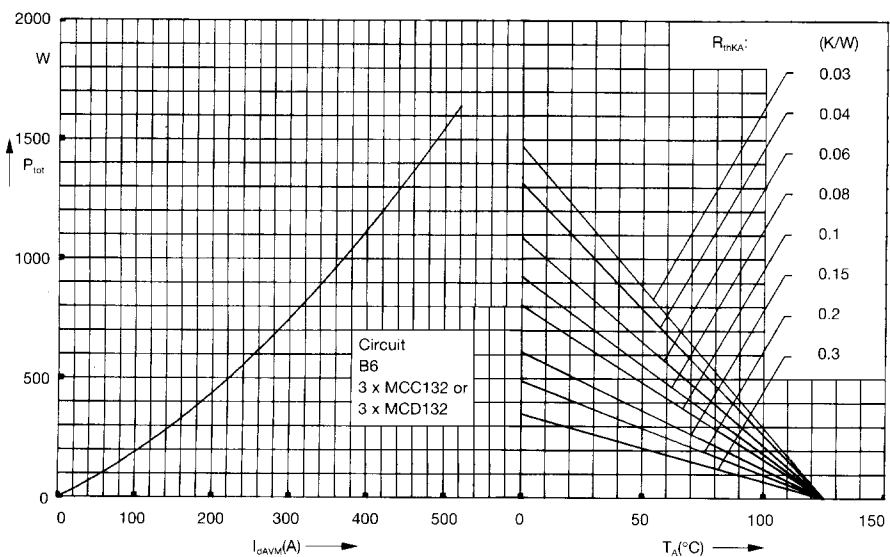

Fig. 6 Three phase rectifier bridge: Power dissipation versus direct output current and ambient temperature

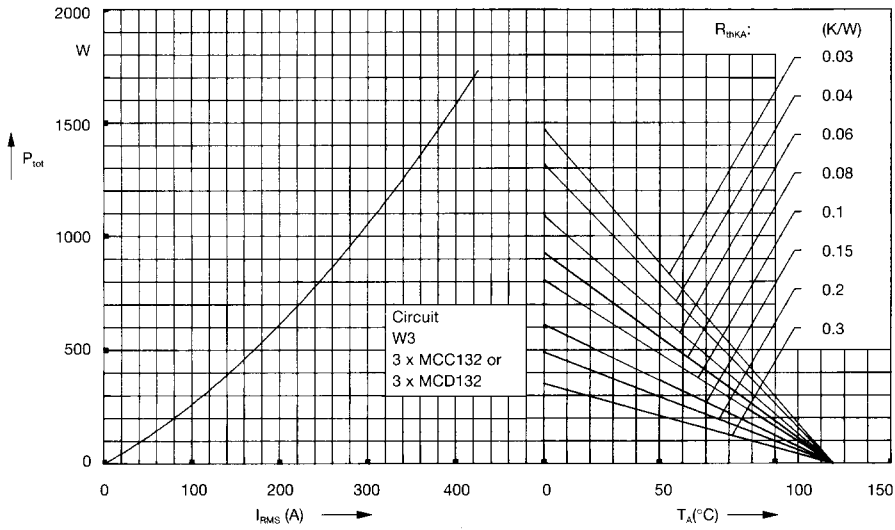

Fig. 7 Three phase AC-controller: Power dissipation versus RMS output current and ambient temperature

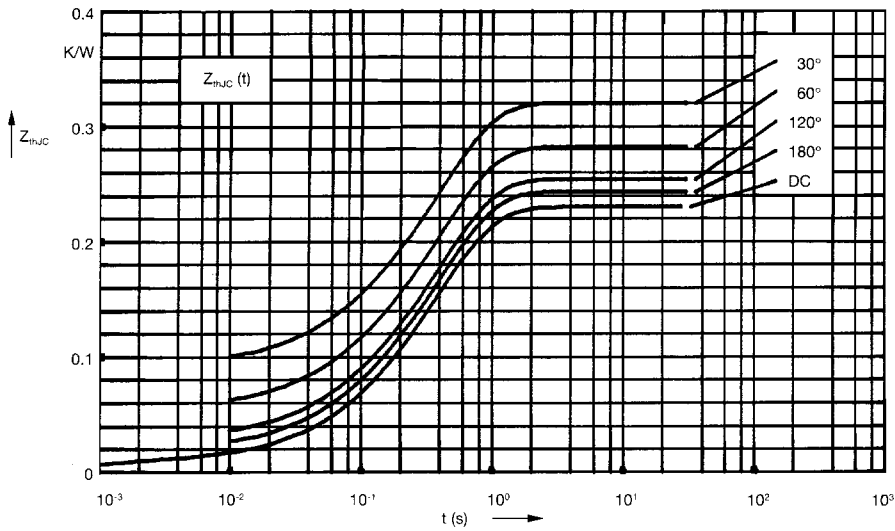

Fig. 8 Transient thermal impedance junction to case (per thyristor or diode)

R_{thJC} for various conduction angles d:

| d | R_{thJC} (K/W) |
|------|------------------|
| DC | 0.230 |
| 180° | 0.244 |
| 120° | 0.255 |
| 60° | 0.283 |
| 30° | 0.321 |

Constants for Z_{thJC} calculation:

| i | R_{thi} (K/W) | t_i (s) |
|---|-----------------|-----------|
| 1 | 0.0095 | 0.001 |
| 2 | 0.0175 | 0.065 |
| 3 | 0.203 | 0.4 |

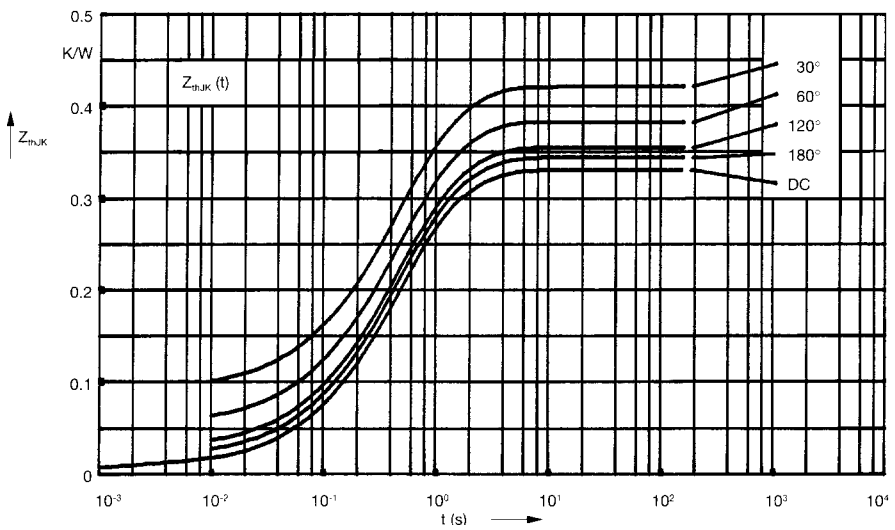

Fig. 9 Transient thermal impedance junction to heatsink (per thyristor or diode)

R_{thJK} for various conduction angles d:

| d | R_{thJK} (K/W) |
|------|------------------|
| DC | 0.330 |
| 180° | 0.344 |
| 120° | 0.355 |
| 60° | 0.383 |
| 30° | 0.421 |

Constants for Z_{thJK} calculation:

| i | R_{thi} (K/W) | t_i (s) |
|---|-----------------|-----------|
| 1 | 0.0095 | 0.001 |
| 2 | 0.0175 | 0.065 |
| 3 | 0.203 | 0.4 |
| 4 | 0.1 | 1.29 |